



YOUR VALUE ADDED DEALER

Visit us at our website:
<http://www.badger-utility.com>



FALL SPECIALS

Expires November 30, 2008

Madison 4334 Daentl Road DeForest, WI 53532 (608) 249-5301 (800) 362-7370	Waukesha N10W24910 Hwy. TJ Pewaukee, WI 53072 (262) 549-3655 (800) 472-1022	Wisconsin Rapids 3112 Hwy. 13 North Wis. Rapids, WI 54495 (715) 424-3310 (800) 522-5661	Wausau 802 Tulip Lane Wausau, WI 54401 (715) 359-8112 (800) 221-5760
--	--	--	---

Kaukauna

1900 Tower Dr., Kaukauna, WI 54130 • (920) 759-9280 • (800) 233-9122



... Year 'Round Fuel Products

All FPPF products are **SATISFACTION GUARANTEED**
OR YOUR MONEY BACK!

PART NO.	TREATS (Gal.)	UNIT SIZE	QTY / CASE	BEFORE 10-1-08	AFTER 10-1-08
FUEL POWER #1 Year-Round Best Seller					
00100	240	8 oz.	24	\$3.72	\$4.43
Cost to treat one gallon of fuel				0.016	0.0185
00101	3,840	1 gal.	4	\$43.93	\$51.100
Cost to treat one gallon of fuel				0.0114	0.0133
00102P	19,200	5 gal.	1	\$153.18	\$182.28
Cost to treat one gallon of fuel				0.0080	0.0095
00103	211,200	55 gal.	1=10 cs.	\$1,213.93	\$1,444.57
Cost to treat one gallon of fuel				0.0057	0.0068
KILLEM Fuel Oil Biocide Kills Bacteria					
00119	1,920	16 oz.	12	\$13.12	\$15.28
Cost to treat one gallon of fuel				0.007	0.008
00191P	76,800	5 gal.	1	\$395.70	\$460.26
Cost to treat one gallon of fuel				0.005	0.006
00120	844,800	55 gal.	1	\$2,921.55	\$3,476.64
Cost to treat one gallon of fuel				0.003	0.004
LUBRICITY PLUS FUEL POWER Lubricates, Disperses Water & Cleans Injectors					
00105	250	32 oz.	12	\$6.56	\$7.63
Cost to treat one gallon of fuel				0.0262	0.0305
00112P	5,000	5 gal.	1	\$104.92	\$122.04
Cost to treat one gallon of fuel				0.0210	0.0244
00113	55,000	55 gal.	1=10 cs.	\$857.09	\$1,019.93
Cost to treat one gallon of fuel				0.0156	0.0185
DIESEL FUEL INJECTOR CLEANER Exceeds L-10 & N-14					
00212	250	32 oz.	12	\$5.78	\$6.73
Cost to treat one gallon of fuel				0.0231	0.0269
00213P	5,000	5 gal.	1	\$97.72	\$113.66
Cost to treat one gallon of fuel				0.0195	0.0227
00214	55,000	55 gal.	1=10 cs.	\$730.50	\$869.30
Cost to treat one gallon of fuel				0.0133	0.0158
POLAR POWER Our Deluxe Anti-Gel & Water Dispersant					
00106	250	32 oz.	12	\$6.76	\$8.04
Cost to treat one gallon of fuel				0.0270	0.0322
00108P	5,000	5 gal.	1	\$105.45	\$125.48
Cost to treat one gallon of fuel				0.0211	0.0251
00109	55,000	55 gal.	1=10 cs.	\$833.39	\$991.73
Cost to treat one gallon of fuel				0.0152	0.0180



Visit us at our website:
<http://www.badger-utility.com>

Madison
 4334 Daentl Road, DeForest, WI 53532
 (608) 249-5301 • (800) 362-7370

Waukesha
 N10W24910 Hwy.TJ, Pewaukee, WI 53072
 (262) 549-3655 • (800) 472-1022

Wisconsin Rapids
 3112 Hwy. 13 North, Wis. Rapids, WI 54495
 (715) 424-3310 • (800) 522-5661

Wausau
 802 Tulip Lane, Wausau, WI 54401
 (715) 359-8112 • (800) 221-5760

Kaukauna
 1900 Tower Dr., Kaukauna, WI 54130
 (920) 759-9280 • (800) 233-9122

FPPF ... Year 'Round Fuel Products

PART NO.	TREATS (Gal.)	UNIT SIZE	QTY / CASE	BEFORE 10-1-08	AFTER 10-1-08
TOTAL POWER The Ultimate Winter Diesel Fuel Treatment					
00317	60	12 oz.	12	\$3.54	\$4.15
Cost to treat one gallon of fuel				0.0590	0.0691
00343	250	32 oz.	12	\$7.90	\$9.26
Cost to treat one gallon of fuel				0.0316	0.0370
00344P	5,000	5 gal.	1	\$120.84	\$141.58
Cost to treat one gallon of fuel				0.0242	0.0283
00345	55,000	55 gal.	1=10 cs.	\$983.95	\$1,170.90
Cost to treat one gallon of fuel				0.0179	0.0213
MELTDOWN Emergency Fuel Treatment For Gelled Fuel					
00124	50	32 oz.	12	\$6.13	\$7.30
00330	200	1 gal.	4	\$19.72	\$23.47
00170	11,000	55 gal.	1=10 cs.	\$802.31	\$954.75
8+ CETANE IMPROVER More Power, Faster Starts & Better Combustion					
00188	250	32 oz.	12	\$8.85	\$10.30
Cost to treat one gallon of fuel				0.0354	0.0412
00122P	5,000	5 gal.	1	\$149.90	\$174.36
Cost to treat one gallon of fuel				0.0300	0.0349
00123	55,000	55 gal.	1=10 cs.	\$1,369.98	\$1,630.27
Cost to treat one gallon of fuel				0.0249	0.0296
FLEET FORMULA YEAR ROUND					
00393	7,500	1 gal.	4	\$60.67	\$46.00
Cost to treat one gallon of fuel				0.0080	0.0061
00395P	37,500	5 gal.	1	\$235.66	\$175.00
Cost to treat one gallon of fuel				0.0062	0.0046
00396	412,500	55 gal.	1=10 cs.	\$1,912.61	\$1,366.00
Cost to treat one gallon of fuel				0.0046	0.0033
FLEET FORMULA WINTER *Treatment ratio depends on outside air temperature.					
00225	1,500-7,500*	1 gal.	4	\$40.70	\$48.43
Cost to treat one gallon of fuel				.0054-.0271	.0064-.0322
00226	7,500-37,500	5 gal.	1	\$152.10	\$181.00
Cost to treat one gallon of fuel				.0040-.02502	.0048-.0241
00227	82,500-412,500	55 gal.	1=10 cs.	\$1,130.79	\$1,345.64
Cost to treat one gallon of fuel				.0027-.0137	.0032-.0163
BIODIESEL WINTER TREATMENT					
00603	250	32 oz.	12	\$7.78	\$9.26
00502P	5,000	5 gal.	1	\$120.21	\$143.05
00550	55,000	55 gal.	1=10 cs.	\$963.70	\$1,146.80
BIODIESEL FUEL POWER					
01300	250	16 oz.	12	\$6.70	\$7.98
00300P	10,000	5 gal.	1	\$153.16	\$182.27
00300D	110,000	55 gal.	1=10 cs.	\$1,213.93	\$1,444.57



All FPPF products are SATISFACTION GUARANTEED OR YOUR MONEY BACK!

Thank you for using FPPF products.



Visit us at our website:
<http://www.badger-utility.com>

Madison
 4334 Daentl Road, DeForest, WI 53532
 (608) 249-5301 • (800) 362-7370

Waukesha
 N10W24910 Hwy. Tj, Pewaukee, WI 53072
 (262) 549-3655 • (800) 472-1022

Wisconsin Rapids
 3112 Hwy. 13 North, Wis. Rapids, WI 54495
 (715) 424-3310 • (800) 522-5661

Wausau
 802 Tulip Lane, Wausau, WI 54401
 (715) 359-8112 • (800) 221-5760

Kaukauna
 1900 Tower Dr., Kaukauna, WI 54130
 (920) 759-9280 • (800) 233-9122

WINTER GOODS PRESEASON PROMO



* The \$1000 qualifying order must be placed by October 31, 2008.
 * The \$1000 qualifying order will receive locked-in pricing through April 1, 2009.

Haldex Brake Systems Air Dryers

DA34100 PUREST Integral Purge Air Dryer
 DA35100 DRYEST System Purge Air Dryer

SPECIAL PRICE \$1000 DEAL*

\$299.95 ea. \$279.95 ea.
\$299.95 ea. \$279.95 ea.

Do you want to eliminate your problems for good? We will pay you \$25.00 each for your Bendix AD9, AD-SP, AD-IP, and WABCO air dryer cores (against the purchase of a NEW Haldex Air Dryer)!

Air Dryer Cartridges

101900X BENDIX AD-2 (REMAN)
 104358X BENDIX AD-4 (REMAN)
 107794X BENDIX AD-9 (REMAN)
 107796 BENDIX AD-9 TYPE (NEW)
 109493X BENDIX AD-IP (REMAN)
 109994K BENDIX AD-SP TYPE (NEW)
 950011K WABCO SS-1200 TYPE (NEW)

\$24.95 ea. \$22.95 ea.
\$22.95 ea. \$21.25 ea.
\$21.95 ea. \$19.40 ea.
\$35.95 ea. \$32.95 ea.
\$64.95 ea. \$59.95 ea.
\$23.95 ea. \$20.50 ea.
\$23.95 ea. \$20.50 ea.

Air Dryers

109685X BENDIX AD-9 HARD SEAT 12 VOLT (REMAN)
 109477X BENDIX AD-IP 12 VOLT (REMAN)
 109991X BENDIX AD-SP 12 VOLT (REMAN)
 955205X WABCO SS-1200 12 VOLT (REMAN)

\$143.95 ea. \$126.95 ea.
\$224.95 ea. \$199.95 ea.
\$176.95 ea. \$166.95 ea.
\$150.95 ea. \$141.95 ea.

Air Dryers Kits / Components

103818K BENDIX AD-4 PURGE VALVE KIT
 65231X BENDIX AD-9 END COVER HARD SEAT (REMAN)
 65654X BENDIX AD-9 END COVER SOFT SEAT (REMAN)
 109686X BENDIX AD-9 PURGE VALVE & HEATER ASSY HD ST (REMAN)
 5004341X BENDIX AD-9 PURGE VALVE & HEATER ASSY SFT ST (REMAN)
 107798K BENDIX AD-9 PURGE VALVE KIT
 109578K BENDIX AD-9 HEATER & THERMOSTAT KIT 12 VOLT
 800404K BENDIX AD-IP PURGE VALVE KIT
 109495K BENDIX AD-IP HEATER & THERMOSTAT KIT 12 VOLT

\$7.95 ea. \$5.95 ea.
\$99.95 ea. \$93.95 ea.
\$99.95 ea. \$93.95 ea.
\$41.95 ea. \$38.95 ea.
\$23.95 ea. \$21.95 ea.
\$16.95 ea. \$14.95 ea.
\$33.95 ea. \$30.95 ea.
\$64.95 ea. \$60.95 ea.
\$55.95 ea. \$52.95 ea.

- 11-5150 Polar Air Coiled Air Line Set, 15 ft. \$49.95 ea.
- 11-8115 15' set, with Red/Blue Handles \$39.95 ea.
- 11-8119 15' set, with Black Handle, Universal \$20.95 ea.
- 22-2171 15' Electrical/Air Hose Assy, Non-ABS, Zinc Plugs ... \$109.95 ea.
- 30-2171 15' Electrical/Air Hose Assy, ABS, Zinc Plugs \$124.95 ea.
- 30-2174 15' Electrical/Air Hose Assy, ABS w/QCP Plugs \$133.95 ea.





Visit us at our website:
<http://www.badger-utility.com>

Madison
 4334 Daentl Road, DeForest, WI 53532
 (608) 249-5301 • (800) 362-7370

Waukesha
 N10W24910 Hwy.TJ, Pewaukee, WI 53072
 (262) 549-3655 • (800) 472-1022

Wisconsin Rapids
 3112 Hwy. 13 North, Wis. Rapids, WI 54495
 (715) 424-3310 • (800) 522-5661

Wausau
 802 Tulip Lane, Wausau, WI 54401
 (715) 359-8112 • (800) 221-5760

Kaukauna
 1900 Tower Dr., Kaukauna, WI 54130
 (920) 759-9280 • (800) 233-9122



PART NO.	TREATS	UNIT SIZE	QTY / CASE	CASE LOT PRICE
WINTER POW-R PLUS Winter Diesel Fuel Treatment				
474-202005	7,500	5 gal.	1	\$105.39
Cost to treat one gallon of fuel				0.014
474-202012	50	12 oz.	12	\$2.50
Cost to treat one gallon of fuel				0.0501
474-202032	250	32 oz.	12	\$5.79
Cost to treat one gallon of fuel				0.0232
474-202055	82,500	55 gal.	1	\$931.08
Cost to treat one gallon of fuel				0.0113
WINTER POW-R PLUS BIODIESEL BioReady Winter Diesel Fuel Treatment				
474-202605	7,500	5 gal.	1	\$154.83
Cost to treat one gallon of fuel				0.021
474-202612	50	12 oz.	12	\$2.65
Cost to treat one gallon of fuel				0.053
474-202632	250	32 oz.	12	\$7.07
Cost to treat one gallon of fuel				0.028
474-202655	82,500	55 gal.	1	\$1,181.25
Cost to treat one gallon of fuel				0.014
WINTER THAW Emergency Diesel Fuel Treatment				
474-202101	—	1 gal.	4	\$16.21
474-202132	—	32 oz.	12	\$4.48
PENCOOL 2000 COOLING SYSTEM TREATMENT				
474-200005	—	5 gal.	1	\$80.84
474-200016	—	16 oz.	12	\$3.20
474-200055	—	55 gal.	1	\$629.38
474-200064	—	64 oz.	6	\$9.12
PENCOOL 3000 COOLING SYSTEM TREATMENT with Stabil-Aid				
474-300005	—	5 gal.	1	\$113.54
474-300016	—	16 oz.	12	\$4.92
474-300055	—	55 gal.	1	\$913.79
474-300064	—	64 oz.	6	\$15.14
NEED-RELEASE EXTENDED LIFE COOLING SYSTEM FILTER				
474-NF2088	—	—	12	\$47.90
474-NF2096	—	Volvo/Mack	12	\$47.90
474-NF20891	—	Mack	12	\$47.90
474-NF2091	—	Mid-Range	12	\$47.90
474-NF2095	—	Cummins ISX	12	\$47.90
NON-CHARGED PENCOOL COOLANT FILTER				
474-NF2999	—	—	12	\$5.93
PENCOOL COOLANT FILTER W/SCA				
474-NF3000	—	—	12	\$6.81



Visit us at our website:
<http://www.badger-utility.com>

Madison

4334 Daentl Road, DeForest, WI 53532
 (608) 249-5301 • (800) 362-7370

Waukesha

N10W24910 Hwy.TJ, Pewaukee, WI 53072
 (262) 549-3655 • (800) 472-1022

Wisconsin Rapids

3112 Hwy. 13 North, Wis. Rapids, WI 54495
 (715) 424-3310 • (800) 522-5661

Wausau

802 Tulip Lane, Wausau, WI 54401
 (715) 359-8112 • (800) 221-5760

Kaukauna

1900 Tower Dr., Kaukauna, WI 54130
 (920) 759-9280 • (800) 233-9122

**10049 - Adjustable
Cam-Over Chain
Binder**
\$21.95

**37032 -
Ratcheting
Winch Bar**
\$53.00

**10092 -
Kwik Winder
Winch Strap
Winder**
\$10.00

**Buy Kinedyne at Badger Utility!
 "BADGER'S BIG 10 SPECIAL"**

		Price	10 or more			Price	10 or more
1820	Standard Winch - Weld-On	\$12.50 ea.	\$11.25 ea.	423040	4" x 30 ft. Strap only with Chain Anchor	\$28.50 ea.	\$25.50 ea.
7820	Lo Pro Winch - Weld-On	\$12.50 ea.	\$11.25 ea.	599940	4" x 30 ft. Ratchet Strap Assembly w/Chain Anchor	\$70.00 ea.	\$63.00 ea.
1820P2	Standard Winch - Portable	\$14.00 ea.	\$12.75 ea.	553040	3" x 30 ft. Ratchet Strap Assembly w/Chain Anchor	\$50.00 ea.	\$45.50 ea.
7820P2	Lo Pro Winch - Portable	\$14.00 ea.	\$12.75 ea.	513039	2" x 30 ft. Ratchet Strap Assembly w/Chain Anchor	\$38.00 ea.	\$34.50 ea.
37030	Standard Winch Bar	\$11.00 ea.	\$10.00 ea.	10092	KWIK WINDER Strap winder	\$10.00 ea.	\$ 9.00 ea.
423021	4" x 30' Strap with flat hook	\$12.00 ea.	\$10.15 ea.	37032	Ratchet Winch Bar	\$53.00 ea.	\$49.00 ea.
463034	4" x 30' Rhino Web Strap with flat hook	\$17.00 ea.	\$15.50 ea.	TS15	15" Goldline Tarp Strap (box/50)	\$29.00	
513020	2" x 30' Ratchet Strap Assembly with flat hook	\$14.75 ea.	\$13.00 ea.	TS21	21" Goldline Tarp Strap (box/50)	\$31.00	
563020	2" x 30' Rhino Web Strap Assy with flat hook	\$18.00 ea.	\$16.00 ea.	TS31	31" Goldline Tarp Strap (box/50)	\$40.00	

**PREMIER
MANUFACTURING CO.**

PR100	Safe-Tite Coupler	\$95.00 ea.
PR130	Coupling	\$135.00 ea.
PR135NT	Coupling	\$210.00 ea.
PR150	Coupling	\$130.00 ea.
PR160	Coupling	\$105.00 ea.
PR16	Pin & Clevis	\$190.00 ea.
PR3	3" Eye	\$75.00 ea.
PR300	3" Eye	\$110.00 ea.
PR270	Pintle Hook	\$245.00 ea.
PR470	Pintle Hook	\$255.00 ea.
PR2200	Pintle Hook	\$255.00 ea.
PR2400	Pintle Hook	\$310.00 ea.



Visit us at our website:
<http://www.badger-utility.com>

Madison

4334 Daentl Road, DeForest, WI 53532
 (608) 249-5301 • (800) 362-7370

Waukesha

N10W24910 Hwy.TJ, Pewaukee, WI 53072
 (262) 549-3655 • (800) 472-1022

Wisconsin Rapids

3112 Hwy. 13 North, Wis. Rapids, WI 54495
 (715) 424-3310 • (800) 522-5661

Wausau

802 Tulip Lane, Wausau, WI 54401
 (715) 359-8112 • (800) 221-5760

Kaukauna

1900 Tower Dr., Kaukauna, WI 54130
 (920) 759-9280 • (800) 233-9122

Tool Boxes

(All Smooth Doors)

425-203	18"x18"x24"	1 Door	\$330.00
425-207	18"x18"x36"	1 Door	\$385.00
425-209	18"x18"x48"	1 Door	\$485.00
425-213	24"x24"x24"	1 Door	\$425.00
425-217	24"x24"x36"	1 Door	\$510.00
425-219	24"x24"x48"	1 Door	\$570.00
425-221	24"x24"x48"	2 Door	\$615.00
425-225	24"x24"x60"	2 Door	\$675.00
425-299	18"x24"x60"	2 Door	\$675.00



Saddle Boxes

425-452	23.5"x28.5"x12"	smooth door w/ step	\$380.00
425-460	22"x21"x18"	smooth door w/ step	\$350.00
425-461	22"x21"x18"	diamond plate door	\$350.00
425-462	23.5"x28.5"x18"	smooth door w/ step	\$465.00
425-470	22"x21"x24"	smooth door	\$395.00
425-472	23.5"x28.5"x24"	smooth door w/ step	\$425.00
425-482	23.5"x28.5"x36"	smooth door w/ step	\$590.00

L.S.R.

425-317328	DL, 68"x70"	w/chain rack	\$915.00
425-317367	DL, 68"x70"	w/jail bar window	\$780.00
425-317369	DL, 68"x70"	w/punched window	\$710.00



SOUTHWEST AGRI-PLASTICS, INC.



Plastic
 Corner
 Prevents
 Tarp Damage

CAS 8x10
 Corner Protector
\$3.00 ea.

100 Qty
\$2.50 ea.

200 Qty
\$2.25 ea.



CACORNER-B
 Tarp Protector
\$2.00 ea.

100 Qty
\$1.75 ea.

200 Qty
\$1.50 ea.

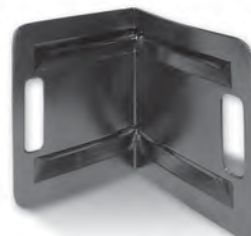



Visit us at our website:
<http://www.badger-utility.com>

Madison

4334 Daentl Road, DeForest, WI 53532
 (608) 249-5301 • (800) 362-7370

Waukesha

N10W24910 Hwy.TJ, Pewaukee, WI 53072
 (262) 549-3655 • (800) 472-1022

Wisconsin Rapids

3112 Hwy. 13 North, Wis. Rapids, WI 54495
 (715) 424-3310 • (800) 522-5661

Wausau

802 Tulip Lane, Wausau, WI 54401
 (715) 359-8112 • (800) 221-5760

Kaukauna

1900 Tower Dr., Kaukauna, WI 54130
 (920) 759-9280 • (800) 233-9122

Grote-Select™ 4" LED Stop/Tail/Turn Lamp

Product Information Sheet

New optic design provides cost effective solution with popular aftermarket termination style.

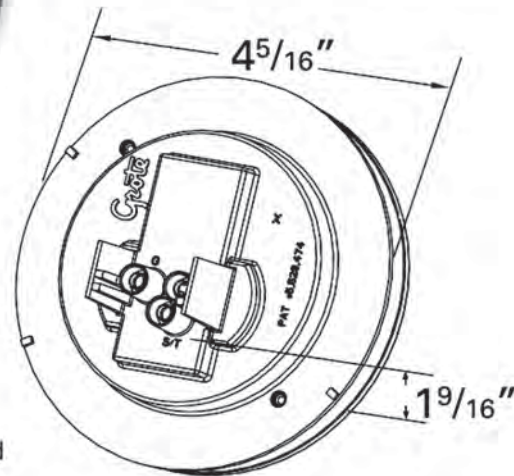

Product Features and Benefits:

- Longer life than incandescent lamps
- Faster light-on response time, for safety, provides increased stopping alert distance than incandescent lamps
- Less current draw than standard incandescent lamps for increased fuel efficiency, more voltage available to other vehicle systems
- Uses existing pigtailed and wiring for cost effective retrofit
- Use with Grote pigtail for an extra year warranty
- Similar look to incandescent light alleviates theft concerns
- Hermetic lens to housing seal prevents moisture intrusion

Product Specs:

54342 Red, Female Pin
54343 Yellow, Female Pin
 Material: Polycarbonate/Acrylic
 FMVSS: S/T/T - I, P2, S, T - Auxiliary - P2
 Finish: Red/Yellow
 Voltage/Amp: Red - 12V - .24A (I,S)/.03A (T)

Part Number	Market	Light Source	Operating Voltage	Amperage	Interchange
54342 - Female Pin	Truck and Trailer	Red LEDs	12V	.24A (I,S)/.03A (T)	NA
54343 - Female Pin	Truck and Trailer	Yellow LEDs	12V	.24A (I,S)/.03A (T)	NA



		EACH	CASE LOT
54342	GROTE SELECT LED S/T/T	\$12.75	\$10.60

www.grote.com



Visit us at our website:
<http://www.badger-utility.com>

Madison

4334 Daentl Road, DeForest, WI 53532
 (608) 249-5301 • (800) 362-7370

Waukesha

N10W24910 Hwy. TJ, Pewaukee, WI 53072
 (262) 549-3655 • (800) 472-1022

Wisconsin Rapids

3112 Hwy. 13 North, Wis. Rapids, WI 54495
 (715) 424-3310 • (800) 522-5661

Wausau

802 Tulip Lane, Wausau, WI 54401
 (715) 359-8112 • (800) 221-5760

Kaukauna

1900 Tower Dr., Kaukauna, WI 54130
 (920) 759-9280 • (800) 233-9122

TruckLite.com

CHOOSE WISELY.
CHOOSE TRUCK-LITE!

YOUR "SEE & BE SEEN" SOURCE FOR LIGHTING, MIRROR & HARNESS SAFETY SYSTEMS

	<p>LIFETIME T-44302R 4" LED SUPER 44 SERIES S/T/T 6 DIODE \$12.95 ea.</p> <p>2YR T-4050 4" LED S/T/T 24 DIODE SIGNALSTAT \$9.95 ea.</p>		<p>LIFETIME T-66250R LED SUPER 66 SERIES OBLONG S/T/T SINGLE DIODE \$18.95 ea.</p> <p>2YR T-6050 LED 60 SERIES OBLONG S/T/T 24 DIODE S/T/T \$14.50 ea.</p>		<p>LIFETIME T-10250R "5" SUPER 10 SERIES M/C \$4.83 ea.</p> <p>LIFETIME T-10250Y 2.5" SUPER 10 SERIES M/C \$5.17 ea.</p> <p>2YR T-1050 2.5" 10 SERIES M/C 13 DIODE SIGNALSTAT RED \$4.22 ea.</p> <p>2YR T-1050A 2.5" 10 SERIES M/C 13 DIODE SIGNALSTAT AMBER \$4.22 ea.</p> <p>3YR T-15250R SUPER 15 SERIES RECT M/C 1 DIODE \$5.37 ea.</p> <p>3YR T-15250Y SUPER 15 SERIES RECT M/C 3 DIODE \$5.74 ea.</p> <p>2YR T-1560 15 SERIES RECT M/C SIGNAL 2 DIODE SIGNALSTAT RED \$3.72 ea.</p> <p>2YR T-1560A 15 SERIES RECT M/C SIGNAL 3 DIODE SIGNALSTAT AMBER \$3.72 ea.</p> <p>3YR T-19250R SUPER 19 SERIES RECT M/C 2 DIODE \$5.09 ea.</p> <p>3YR T-19250Y SUPER 19 SERIES RECT M/C 4 DIODE \$5.45 ea.</p> <p>2YR T-1960 19 SERIES RECT M/C 4 DIODE SIGNALSTAT RED \$4.98 ea.</p> <p>2YR T-1960A 19 SERIES RECT M/C 4 DIODE SIGNALSTAT AMBER \$4.98 ea.</p>		<p>LIFETIME T-21251R SUPER 21 SERIES RECT M/C REFLEX \$6.95 ea.</p> <p>LIFETIME T-21251Y SUPER 21 SERIES RECT M/C REFLEX \$7.67 ea.</p> <p>LIFETIME T-30250R 2" SUPER 30 SERIES M/C OMNIVOLT 2 DIODE \$4.60 ea.</p> <p>LIFETIME T-30250Y 2" SUPER 30 SERIES M/C OMNIVOLT 3 DIODE \$5.17 ea.</p> <p>2YR T-3050 2" 30 SERIES M/C 10 DIODE SIGNALSTAT RED \$4.75 ea.</p> <p>2YR T-3050A 2" 30 SERIES M/C 10 DIODE SIGNALSTAT AMBER \$4.75 ea.</p> <p>3YR T-33250R SUPER 33 SERIES 3/4" M/C \$5.42 ea.</p> <p>3YR T-33250Y SUPER 33 SERIES 3/4" M/C \$5.80 ea.</p> <p>LIFETIME T-35200R SUPER 35 SERIES RECT M/C OMNIVOLT \$5.02 ea.</p> <p>LIFETIME T-35200Y SUPER 35 SERIES RECT M/C OMNIVOLT \$5.51 ea.</p> <p>2YR T-91243Y 7" S/T/T & REAR TURN 47 DIODE HARDWIRED \$30.65 ea.</p> <p>2YR T-91244R 7" S/T/T & REAR TURN 47 DIODE HARDWIRED \$30.65 ea.</p> <p>2YR T-2750 RED/AMBER DOUBLE FACED PEDESTAL LAMP 21 DIODE \$28.46 ea.</p> <p>2YR T-2751 RED SINGLE FACE PEDESTAL LAMP 21 DIODE \$17.08 ea.</p> <p>2YR T-2751A AMBER SINGLE FACE PEDESTAL LAMP 21 DIODE \$17.08 ea.</p>																																																																																																																																																																																					
--	---	--	--	--	---	--	---	--	--	--	--	--	--	--	--	--	--	--	--	--	--	--	--	--	--	--	--	--	--	--	--	--	--	--	--	--	--	--	--	--	--	--	--	--	--	--	--	--	--	--	--	--	--	--	--	--	--	--	--	--	--	--	--	--	--	--	--	--	--	--	--	--	--	--	--	--	--	--	--	--	--	--	--	--	--	--	--	--	--	--	--	--	--	--	--	--	--	--	--	--	--	--	--	--	--	--	--	--	--	--	--	--	--	--	--	--	--	--	--	--	--	--	--	--	--	--	--	--	--	--	--	--	--	--	--	--	--	--	--	--	--	--	--	--	--	--	--	--	--	--	--	--	--	--	--	--	--	--	--	--	--	--	--	--	--	--	--	--	--	--	--	--	--	--	--	--	--	--	--	--	--	--	--	--	--	--	--	--



Visit us at our website:
<http://www.badger-utility.com>

Madison

4334 Daentl Road, DeForest, WI 53532
 (608) 249-5301 • (800) 362-7370

Waukesha

N10W24910 Hwy.TJ, Pewaukee, WI 53072
 (262) 549-3655 • (800) 472-1022

Wisconsin Rapids

3112 Hwy. 13 North, Wis. Rapids, WI 54495
 (715) 424-3310 • (800) 522-5661

Wausau

802 Tulip Lane, Wausau, WI 54401
 (715) 359-8112 • (800) 221-5760

Kaukauna

1900 Tower Dr., Kaukauna, WI 54130
 (920) 759-9280 • (800) 233-9122

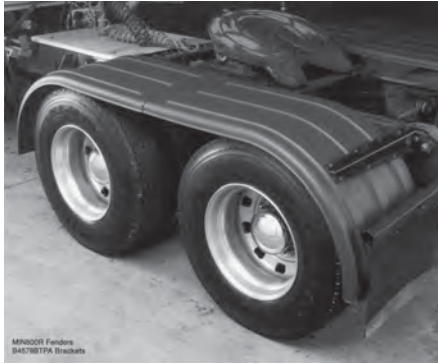

MIN800B Full Fender Sets

B4578 BTPA Brackets
\$600.00 Black in Stock



MIN800PL-SP Liquid Platinum

\$850.00
 Special Purchase - While Supply Lasts



MIN450B Half Fender Sets

B4850 BTPA Brackets
\$250.00
 Black in Stock

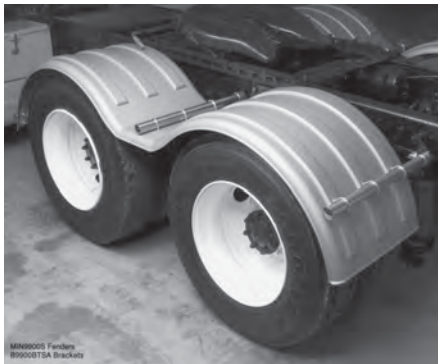

MIN9900B Full Fender Sets

B9900 BTSA Brackets
\$525.00
 Black in Stock

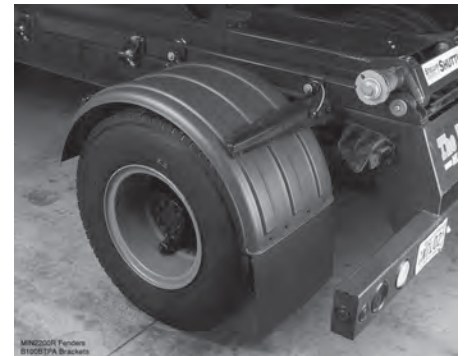

MIN2200B Full Fender Sets

B100 BTPA Brackets
\$250.00 per axle
 Black in Stock



TU822003R



TU822003P

TU822001



TU827200



TU827201

All Stainless Steel Toolboxes

Part #	Description	RETAIL
TU823503	18" x 18" x 48" Single Door	\$375.00
TU822000	18" x 24" x 24" Single Door	\$315.00
TU823000	18" x 24" x 36" Single Door	\$375.00
TU823500	18" x 24" x 48" Single Door	\$440.00
TU823501	18" x 24" x 48" Double Door	\$475.00
TU824000	18" x 24" x 60" Single Door	\$565.00
TU824001	18" x 24" x 60" Double Door	\$595.00
TU822001	24" x 24" x 24" Single Door	\$325.00
TU826500	24" x 24" x 36" Single Door	\$395.00
TU827000	24" x 24" x 48" Single Door	\$475.00
TU827001	24" x 24" x 48" Double Door	\$500.00
TU827200	24" x 24" x 60" Single Door	\$595.00
TU827201	24" x 24" x 60" Double Door	\$625.00
TU822503	Pete Style Batt Box	\$795.00



Visit us at our website:
<http://www.badger-utility.com>

Madison
 4334 Daentl Road, DeForest, WI 53532
 (608) 249-5301 • (800) 362-7370

Waukesha
 N10W24910 Hwy. TJ, Pewaukee, WI 53072
 (262) 549-3655 • (800) 472-1022

Wisconsin Rapids
 3112 Hwy. 13 North, Wis. Rapids, WI 54495
 (715) 424-3310 • (800) 522-5661

Wausau
 802 Tulip Lane, Wausau, WI 54401
 (715) 359-8112 • (800) 221-5760

Kaukauna
 1900 Tower Dr., Kaukauna, WI 54130
 (920) 759-9280 • (800) 233-9122



PROFESSIONAL LIFTING EQUIPMENT

BOTTLE JACKS



AIR/HYDRAULIC FLOOR JACKS

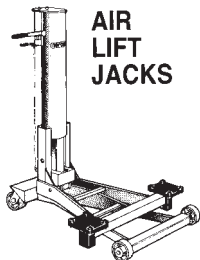

AIR LIFT JACKS

TRUCK RAMPS and JACK STANDS

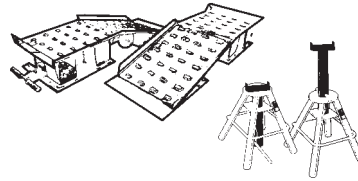

UNDER HOIST STANDS and TRAILER STABILIZING STAND

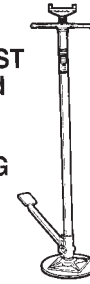

WHEEL DOLLIES

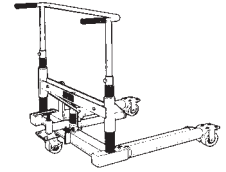

Model #	Description	SPECIAL
463-76412	12 Ton Standard Bottle Jack	\$95.00
463-76508	8 Ton Bottle Jack	\$89.00
463-76512	12 Ton Low Height Bottle Jack	\$93.00
463-76520	20 Ton Standard Bottle Jack	\$145.00
463-71230A	2-1/4 Ton Floor Jack	\$175.00
463-72040A	Brake Drum Handler	\$270.00
463-72200C	22 Ton Air/Hyd Floor Jack w/ 3 Adapters & Holder	\$630.00
463-81004C	3 Ton Capacity Jack Stands, pair	\$32.00
463-81006D	6 Ton Capacity Jack Stands, pair	\$50.00
463-81022AI	20 Ton Capacity Trailer Stabilizer Stand	\$125.00
463-81209I	10 Ton Capacity Jack Stands - Pin Type - Medium	\$165.00
463-81210I	10 Ton Capacity Jack Stands - Pin Type - High	\$225.00
463-777C	1000 lb. Motorcycle Lift	\$395.00

All NORCO products Carry a LIFETIME Warranty

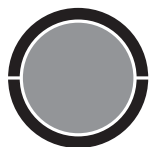

Dependable Brake, Inc.
Uni-Bond Brake, Inc.

Quality Relined Brake Shoes

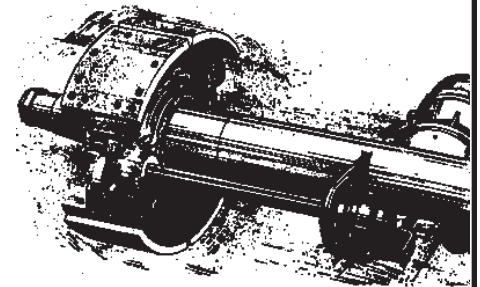

OUTRIGHT, NO CORE CHARGE
ZINC DICHROMATE PLATED, GUARANTEED TO ELIMINATE RUST JACKING

		I+ KITS EACH	40+ KITS EACH
DBP164515QO	20,000# UNI-BOND RELINED SHOES AND HARDWARE KIT, OUTRIGHT	\$39.00	\$37.00
DBP164707QO	20,000# UNI-BOND RELINED SHOES AND HARDWARE KIT, OUTRIGHT	\$42.00	\$39.00



Visit us at our website:
<http://www.badger-utility.com>

Madison
 4334 Daentl Road, DeForest, WI 53532
 (608) 249-5301 • (800) 362-7370

Waukesha
 N10W24910 Hwy.TJ, Pewaukee, WI 53072
 (262) 549-3655 • (800) 472-1022

Wisconsin Rapids
 3112 Hwy. 13 North, Wis. Rapids, WI 54495
 (715) 424-3310 • (800) 522-5661

Wausau
 802 Tulip Lane, Wausau, WI 54401
 (715) 359-8112 • (800) 221-5760

Kaukauna
 1900 Tower Dr., Kaukauna, WI 54130
 (920) 759-9280 • (800) 233-9122

SCC

Security Chain Co.

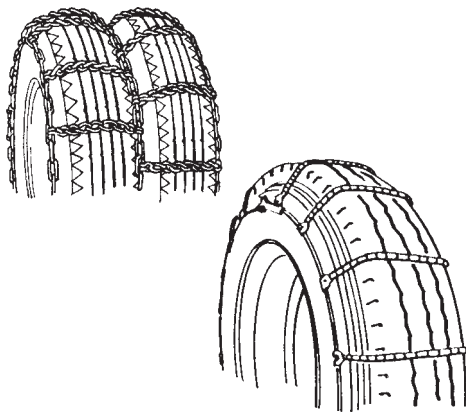
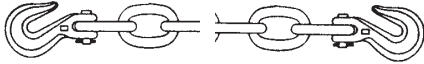

**Buy 100 Sets
 Mix/Match and receive
 an additional
 5% Rebate**

SSC LOAD RESTRAINT

		Maximum Chain	Working Load Limit	EACH	12 or more EACH
H5023-4152	Lever Binder	5/16 - 3/8	5,400#	\$14.50	\$13.50
H5023-4252	Lever Binder	3/8 - 1/2	9,200#	\$24.95	\$23.25
H5123-4152	Ratchet Binder	5/16 - 3/8	5,400#	\$21.95	\$20.50
H5123-4252	Ratchet Binder	3/8 - 1/2	9,200#	\$24.25	\$22.50
H5123-4452	Ratchet Binder	1/2 - 5/8	13,000#	\$33.65	\$31.50
H5125-0658	QuikBinder Plus	5/16 - 3/8	5,400#	\$28.50	\$26.50
H5125-0858	QuikBinder Plus	3/8 - 1/2	9,200#	\$34.75	\$32.50
H5025-0652	SCC ProLok 66	5/16 - 3/8	6,600#	\$22.25	\$20.75
	Adjustable Lever Binder G70 Chain Assembly Safety Latch in Handle				

			EACH	30 or more EACH
5/16GRAB	(S-7) 5/16	Clevis Grab Hook	\$3.00	\$2.50
3/8GRAB	(S-7) 3/8	Clevis Grab Hook	\$4.00	\$3.25

SSC TRANSPORT BINDER CHAIN

		Working Chain	Load Limit	EACH	12 or more EACH
5/16 x 20	(S-7), 5/16" x 20', Premium Short Link		4,700#	\$33.00	\$25.95
3/8 x 20	(S-7), 3/8" x 20', Premium Short Link		6,600#	\$43.50	\$33.95
5/16CHAIN	Grade 70 Bulk			PER FOOT \$2.20	550' or more PER FOOT \$1.95
3/8CHAIN	Grade 70 Bulk			PER FOOT \$2.90	400' or more PER FOOT \$2.60

SSC TIRE CHAINS, CABLE AND LINK

SINGLES		\$59.95 ea.	\$54.95	12 or more EACH	25 or more EACH
DOUBLES		\$109.95 ea.	\$102.95	6 or more EACH	12 or more EACH

Buy Smart! Buy from the full line stocking distributor! Badger stocks the Security Line 12 months a year. We can answer your questions and fulfill your tire chain and load restraint requirements.



DURABILT LOAD RESTRAINT

		Maximum Chain Load	Working Load Limit	EACH	12 or more EACH
DB-II	Lever Binder	5/16 - 3/8	5,400#	\$18.00	\$16.00
DB-III	Lever Binder	3/8 - 1/2	9,200#	\$34.00	\$31.00
DR-1	Ratchet Binder	5/16 - 3/8	6,600#	\$40.00	\$36.00
DR-2	Ratchet Binder	3/8 - 1/2	11,300#	\$47.00	\$42.50

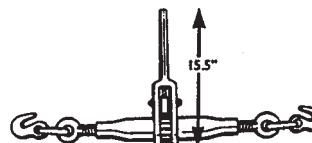



Visit us at our website:
<http://www.badger-utility.com>

Madison
 4334 Daentl Road, DeForest, WI 53532
 (608) 249-5301 • (800) 362-7370

Waukesha
 N10W24910 Hwy. Tj, Pewaukee, WI 53072
 (262) 549-3655 • (800) 472-1022

Wisconsin Rapids
 3112 Hwy. 13 North, Wis. Rapids, WI 54495
 (715) 424-3310 • (800) 522-5661

Wausau
 802 Tulip Lane, Wausau, WI 54401
 (715) 359-8112 • (800) 221-5760

Kaukauna
 1900 Tower Dr., Kaukauna, WI 54130
 (920) 759-9280 • (800) 233-9122

NATIONAL SEATING



Premium Leather Series:

Gray/Gray Gray/Red
 Gray/Blue Tan/Brown
 Gray/Black Black/Black

\$795.00

- Improved Shoulder Support
- Contoured Side Bolsters
- Triple Lumbar Support
- Driver Friendly Controls
- Re-Engineered Seat Base
- Genuine Leather Seat with Perforated leather inserts
- Includes Armrests



Premium Series:

2-Tone Gray 2-Tone Red
 2-Tone Blue 2-Tone Brown
 2-Tone Black

\$550.00

- Same Features as Indicated in the Standard Series PLUS
- 6-Way Front Cushion Adjustment
- Power Cushion and Back Bolster
- Base Shroud and Bellows
- Triple Lumbar Support
- 6-Button Seat
- All Mordura Cloth
- Includes Armrests



Standard Plus Series:

2-Tone Gray 2-Tone Red
 2-Tone Blue 2-Tone Brown
 2-Tone Black

\$395.00

- All Mordura Cloth
- Contoured Cushions
- 7" Fore and Aft Slide
- Front Cushion Adjustent
- 6 to 23 Degree Incline
- Power Air Lumbar
- Rear Cushion Adjustment,
- Chugger Snubber
- Available in Mid- & Low-Back
- Includes Armrests

II HIGH PERFORMANCE

AN UPGRADE FOR YOUR SEATING COMFORT

HP allows you to ride in luxurious comfort.

HP is the ergonomic seat of the new generation

FEATURES:

- Adjustable Dual Armrest
- 1.5" Wider Opening between Armrest than Previous Model
- 23" Plus Seat Cushion
- 2" Wider Cushion
- 3 Position Rear Cushion Adjust
- 3 Chamber Air Lumbar
- Bellows
- 6 to 23 Degree Recline
- 8.9" fore and aft slide
- 6 Position Front Cushion Adjust
- 2 Position Armrest Spacing
- Genuine Leather or Premium Cloth
- Available in Solid - Black and Grey
- Chugger Snubber
- Cushion & Back Bolsters
- Map Pocket
- Lower Natural Frequency
- Improved Road Isolation
- More Stability
- Quieter
- Backcyclers® Motion allows alternating muscles and ligaments to share strain/rest cycles.
- Optional Chrome Accents



High Performance Cloth

\$629.00

- w/ wide arm rests **\$718.00**
- w/ wide chrome accent package **\$729.00**
- w/ wide arm rests and chrome accent package **\$790.00**

High Performance Leather

\$859.00

- w/ wide arm rests **\$969.00**
- w/ wide chrome accent package **\$989.00**
- w/ wide arm rests and chrome accent package **\$1,029.00**

KAB Seating 211-005-05

\$259.00

200 Series, Mechanical, Vinyl





Visit us at our website:
<http://www.badger-utility.com>

Madison

4334 Daentl Road, DeForest, WI 53532
 (608) 249-5301 • (800) 362-7370

Waukesha

N10W24910 Hwy.TJ, Pewaukee, WI 53072
 (262) 549-3655 • (800) 472-1022

Wisconsin Rapids

3112 Hwy. 13 North, Wis. Rapids, WI 54495
 (715) 424-3310 • (800) 522-5661

Wausau

802 Tulip Lane, Wausau, WI 54401
 (715) 359-8112 • (800) 221-5760

Kaukauna

1900 Tower Dr., Kaukauna, WI 54130
 (920) 759-9280 • (800) 233-9122

STEMCO KAISER



Product Line	Application	SPECIAL
Qwik Kits	King Pin Kits	
K122E	Eaton Axles on Kenworths and Peterbilts from 1996 and newer	\$250.54
K120E	Eaton Axles on Kenworths and Peterbilts from 1996 and older	\$312.15
K146E	Eaton Axles	\$324.41
K147E	Eaton Axles	\$315.31
K80G	GM Top Kick Kodiak	\$322.63
K110G	GM Top Kick Kodiak	\$449.60
K961L	Rockwell axles that fit most Freightliners and some Sterlings	\$283.53
K981R	Rockwell axles 1997 and after/ Unitized Hub application	\$314.55
K931L	Rockwell	\$273.26
KH931L	Rockwell	\$328.30
K533M	Mack	\$327.40
K616M	Mack	\$372.71
K122V	Volvo Kit	\$429.26
K102 I	International	\$239.08
K120I	International	\$311.44
K140I	International	\$254.75

Spring Pins

BSP38-2	Sprinpins for Freightliners IIM38-2	\$9.52
BSP49-1	Springpins for International	\$9.88
BSP50-1	Springpins for Peterbilts IIM50-1	\$10.94
BSP70-1	Threaded Springpins for Kenworths Rear & Hanger(5296) IIM70-1	\$15.20
BSP67-1	Threaded Springpins for Kenworths Front (6262) IIM67-1	\$18.92

Springpin Bushings

BSL120-9	“RNK Bushings for Freightliner , International, Peterbilt”	\$9.94
BSG5295-1	Bushings for all listed Kenworth threaded pins	\$9.94

Service Tools

ST-100-1	Short T handle wrench	\$18.58
ST-100-2	Long T Handle wrench	\$20.11
ST-1125-5	Air Hammer Drive Arbor for both Removal and Installation of Spring Pin Bushings	\$31.87
ST-1250-5	Air Hammer Drive Arbor for both Removal and Installation of Spring Pin Bushings	\$36.11



Visit us at our website:
<http://www.badger-utility.com>

Madison
 4334 Daentl Road, DeForest, WI 53532
 (608) 249-5301 • (800) 362-7370

Waukesha
 N10W24910 Hwy.TJ, Pewaukee, WI 53072
 (262) 549-3655 • (800) 472-1022

Wisconsin Rapids
 3112 Hwy. 13 North, Wis. Rapids, WI 54495
 (715) 424-3310 • (800) 522-5661

Wausau
 802 Tulip Lane, Wausau, WI 54401
 (715) 359-8112 • (800) 221-5760

Kaukauna
 1900 Tower Dr., Kaukauna, WI 54130
 (920) 759-9280 • (800) 233-9122

MIRRORS

*"Absolutely the
 Best Mirrors Made"
 100% Satisfaction
 Guaranteed!*



CONVEX MIRRORS

RETRAC #	CHAMCAL#	Description	SPECIAL EACH	SPECIAL 6+ EACH
541-610673	258-10801	8" Stainless Steel Convex, with brkt	\$10.00	\$9.10
541-609898	258-12801	8" Stainless Steel Convex, offset stud, with brkt	\$11.25	\$10.25

WEST COAST MIRRORS

RETRAC #	CHAMCAL#	Description	SPECIAL EACH	SPECIAL 6+ EACH
541-601272	258-20301	7x16 "OEM" Style, Stainless Steel	\$16.85	\$15.00
541-601285	258-20311	7x16 "OEM" Style, Stainless Steel, Heated	\$21.00	\$20.00
541-610278	258-20100	6x16 Economy, Aluminum	\$5.00	

HEAVY DUTY MIRROR ASSY

RETRAC #	CHAMCAL#	Description	SPECIAL EACH	SPECIAL 6+ EACH
541-604677		Tripod Fender Assy, Stainless Steel (mirror head not included)	\$34.00	\$31.00
541-604696		Hood Mount Assy, Stainless Steel, Convex Mirror Not Included	\$33.00	\$30.00

AERODYNAMIC MIRROR HEAD

RETRAC #	CHAMCAL#	Description	SPECIAL EACH	SPECIAL 6+ EACH
541-613510	Manual	SV, (single vision), Black	\$75.00	\$69.00
541-613511	Manual	SV, Chrome	\$105.00	\$96.00
541-613512	Manual	SV, Heated, Black	\$87.00	\$80.00
541-613513	Manual	SV, Heated, Chrome	\$118.00	\$108.00
541-613412	Motorized	SV, Heated, Black	\$122.00	\$111.00
541-613413	Motorized	SV, Heated, Chrome	\$152.00	\$139.00
541-613422	Motorized	DV (dual vision), Heated, Black	\$164.00	\$149.00
541-613423	Motorized	DV (dual vision), Chrome	\$195.00	\$177.00
541-613460	Motorized	Switch package	\$16.50	\$15.40



Visit us at our website:
<http://www.badger-utility.com>

Madison

4334 Daentl Road, DeForest, WI 53532
 (608) 249-5301 • (800) 362-7370

Waukesha

N10W24910 Hwy. T, Pewaukee, WI 53072
 (262) 549-3655 • (800) 472-1022

Wisconsin Rapids

3112 Hwy. 13 North, Wis. Rapids, WI 54495
 (715) 424-3310 • (800) 522-5661

Wausau

802 Tulip Lane, Wausau, WI 54401
 (715) 359-8112 • (800) 221-5760

Kaukauna

1900 Tower Dr., Kaukauna, WI 54130
 (920) 759-9280 • (800) 233-9122

HIGHLIGHTER™ SOLARIS™ LED
 MINI-LIGHTBARS

454201-02

LED Highlighter, Amber, Permanent Mount

\$349.00 each

\$315.00 each, 10 or more



FEATURES:

- Low-profile modular design utilizing industry leading HIGHLIGHTER styling and mounting footprint.
- Incorporates ROC LED technology.
- Uniform 360-degree light distribution; no dark spots or shadows.
- More than twenty user selectable flash patterns.
- Magna Select™ feature; easily switch flash patterns using a magnet.
- Synchronize or alternately flash with multiple HIGHLIGHTER units or a variety of other LED light heads.
- Contains two-channel high-side flasher that synchronizes other light heads (up to 7.5 amps per channel).
- Variety of mounting options.

APPROVALS:

- Meets SAE J845 Class 1 specifications



HIGHLIGHTER SOLARIS LED shown with riser mount kit option.



FEDERAL SIGNAL

www.fedsig.com



"Keeping fleets safe, connected and profitable."

503-5211A Preco Incandescent Rotary Mini-Bar



The 5200 series mini-bar rotator family by Preco Electronics has combined the latest in electronics with state-of-the-art light projection technology! Multiple configurations are available that allow easy customization for your work environment. From available light filters and outer lens colors to various mounting options, this mini-bar is all that you need for your safety lighting needs.

Flashes / Min:	240 Total Flashes
Voltage:	12 Volts DC
SAE Rating:	J845 Class 1
Other Certifications:	e'CE California Title 13
Amp Draw:	8.7 Amps
Wattage:	55 Watts
Standard Mount:	Flush
Lens Colors:	Amber
Bulb:	BB5211
Dimensions:	15.8"(401mm) L x 5.9"(150mm) H x 7.1"(180mm) W

\$69.95 ea. **\$59.95 ea.** (12 or more)



Visit us at our website:
<http://www.badger-utility.com>

Madison
4334 Daentl Road, DeForest, WI 53532
(608) 249-5301 • (800) 362-7370

Waukesha
N10W24910 Hwy.TJ, Pewaukee, WI 53072
(262) 549-3655 • (800) 472-1022

Wisconsin Rapids
3112 Hwy. 13 North, Wis. Rapids, WI 54495
(715) 424-3310 • (800) 522-5661

Wausau
802 Tulip Lane, Wausau, WI 54401
(715) 359-8112 • (800) 221-5760

Kaukauna
1900 Tower Dr., Kaukauna, WI 54130
(920) 759-9280 • (800) 233-9122



The Original (And The Best) Aluminum Protection Bars / Deer Guards / Grille Guards

Standard 2 Bar Guards \$750.00

Standard Pickup 2 Bar Guard (w/ Liner) \$750.00

Standard 3 Bar Guards \$950.00



- Animal collision protection
- 50 – 75 lbs. Total weight
- SCH 40 T6063 Aluminum
- Polished standard, brushed or powder coated available
- Minimizes down time
- Easy installation, no drilling
- Customized, personalized options available

We have guards to fit:

Chevrolet (GMC) Pickups: 1500, 2500, 3500

Dodge Pickups: 1500, 2500

Ford Pickups: F150, 250, 350

Ford Vans: E150, 250, 350

Ford Trucks: F450, 550, 650, 750

Freightliner: 104 (M2), 112 (M2), CENTURY, CLASSIC, COLUMBIA, CONDOVA, FL60, FL70, FL112, FLD120

Hino

International: 4200, 4300, 4400, 4600, 4700, 7600, 8600, 9100, 9200, 9300, 9400, 9900

Kenworth: T2000, T300, T600, T800, W900

Mack: CH, GRANITE, VISION

Peterbilt: 330, 335, 357, 359, 377, 378, 379, 385, 386, 387

Sterling: ACTERRA, LT, SILVER STAR

Volvo: TS, VN, VT880, WG

Western Star: 4964

**If your truck is not listed, ask!
Our list continues to grow and we custom build!**

The NEW Guardian "Fleet" Gard

Heavy Duty Construction • Double Lined

Natural Alum Color Powdercoat

2 Bar Guard w/ XTRA Top

Available for all models using the 2 Bar Guard

\$695.00 each

(650.00 each qty. 10 or more)





Visit us at our website:
<http://www.badger-utility.com>

Madison
 4334 Daentl Road, DeForest, WI 53532 (608) 249-5301 • (800) 362-7370

Wisconsin Rapids
 3112 Hwy. 13 North, Wis. Rapids, WI 54495 (715) 424-3310 • (800) 522-5661

Waukesha
 N10W24910 Hwy. TJ, Pewaukee, WI 53072 (262) 549-3655 • (800) 472-1022

Wausau
 802 Tulip Lane, Wausau, WI 54401 (715) 359-8112 • (800) 221-5760

Kaukauna
 1900 Tower Dr., Kaukauna, WI 54130 (920) 759-9280 • (800) 233-9122

CLOSEOUTS

KAUKAUNA

PART NUMBER	DESCRIPTION	OH	SALE PRICE
LFF1003	FILTER	12	\$16.91 ea.
H-16319-08	HANGER	2	\$136.28 ea.
AS-4320	AIR SPRING (FS6910)	2	\$48.30 ea.
AS-8406	AIR SPRING, HENDRICKSON (FS9287)	1	\$66.50 ea.
69790	TODCO SEAL RETAINER	1	\$7.70 ea.
W-1715	WHITING HANDLE	1	\$1.05 ea.
SET449-410	BEARING SET (HM418445/HM418410)	2	\$31.50 SET
SET582-72	BEARING SET (582/572)	5	\$20.30 SET
MTP8671QR7350	MERITOR TP AXLE	1	\$489.30 ea.
448-625120	5" AIR TUBE 10 FT LONG	1	\$38.50 ea.
231141-34L	ARM REST NATIONAL SEAT BROWN	1	\$17.42 ea.
231141-34R	ARM REST NATIONAL SEAT BROWN	1	\$17.42 ea.
W-343-11.5X90	WHITING DOOR PANEL	1	\$29.40 ea.
S-14587-9	SHOCK STRAP KIT	38	\$15.97 ea.
63501L	FIFTH WHEEL KIT	1	\$180.13 ea.
LAF9472	AIR FILTER GMC ASTRO VAN	9	\$28.52 ea.
LH4589G	Allison 29540493 (Contains two filters)	6	\$35.48 ea.
600-5501	DATATRAC	8	\$37.75 ea.
AQ961110	ABS KIT	4	\$188.20 ea.
UTL-250-0A	OXY / ACET TORCH HOSE REEL WITH HOSE	1	\$253.18 ea.
TRA1492	SPRING	3	\$61.01 ea.
RS137012X	37-MT 10 TOOTH PINION	1	\$211.52 ea.
M-3173-R	CAMSHAFT M16WK103-23 / 2210-Z-6344	1	\$21.15 ea.
2721-0000-00	43' PRODUCE CHUTE FITS CARRIER	1	\$99.23 ea.
F65107	GAS SHOCK	1	\$48.30 ea.
F65412	GAS SHOCK	2	\$51.40 ea.
12103	DRAIN VALVE	17	\$6.03 ea.
KN31400	PRESSURE RELIEF VALVE	6	\$10.94 ea.
GD#42500813	3-HOLE HINGES	7	\$9.84 ea.
400-10216	AUTOSLACK	7	\$61.20 ea.
CA00011-FT	GREAT DANE DOOR SEAL	266	\$1.16 ea.
CR950014	PURGE KIT	1	\$38.21 ea.
CR950015	THERMOST	3	\$53.23 ea.
12/3-50FT-CORD	EXT CORD	1	\$48.94 ea.
12/3-100FT-CORD	EXT CORD	2	\$85.14 ea.
1035AX	AMBR LAMP	27	\$5.08 ea.
01300	BIODIESEL FUEL ADDITIVE	26	\$6.17 ea.
10049	ADJUSTABLE CHAIN BINDER	11	\$21.13 ea.
620201	VISIBEAM	1	\$266.84 ea.
JB104	JACK BAR	9	\$41.59 ea.

WAUKESHA

SPRING AND SUSPENSION

CHA54	NO.2 TRQ ROD BUSHING (CHALMERS 800010)	6	\$47.83 ea.
F66677	GAS MAGNUM 60 S	4	\$15.00 ea.
LN107A	SAI579 LOCK NUT GR.C (HENDRICKSON 29896)	8	\$1.00 ea.
F66897	GAS MAGNUM 60 S	4	\$31.00 ea.
43-694	SPG, F-T 22859(FORD F6HZ5310KA)	4	\$242.78 ea.
TRA017	SINGLE LEAF SPRING 19093(FRUEHAUF UCD9637)	1	\$84.71 ea.
43-390	4/I DRIVE AXLE SPRING (15/PLORD DOHZ5310C)	2	\$300.48 ea.
43-698	9/W LEAF STEER AXLE SPRING (FORD F6HZ5310ACA)	1	\$292.81 ea.
50-267	10 LEAF DRIVE AXLE SPRING	2	\$206.97 ea.
IH22	NAVISTAR TORQUE ROD (501565C2)25-3	3	\$143.03 ea.
AS-4431	FS8008 AIR SPRING	1	\$134.84 ea.
AS-4455	FS7843 AIR SPG	3	\$185.41 ea.
AS-8311	FS#9039, GY#1R12-095	1	\$84.14 ea.
AS-8313	FS9122 GY1R13-038/04	2	\$140.16 ea.
AS-8502	FS9471 AIR SPG	1	\$128.41 ea.
72-43-1SP	5,000# 5 LEAF TRAILER SPRING	1	\$27.78 ea.
72-44-1SP	6,000# 6 LEAF TRAILER SPRING	17	\$27.78 ea.
U7105R-SP	UBOLT 7/8x5x10 round top ubolt	2	\$3.33 ea.



Visit us at our website:
<http://www.badger-utility.com>

Madison
 4334 Daentl Road, DeForest, WI 53532
 (608) 249-5301 • (800) 362-7370

Waukesha
 N10W24910 Hwy.TJ, Pewaukee, WI 53072
 (262) 549-3655 • (800) 472-1022

Wisconsin Rapids
 3112 Hwy. 13 North, Wis. Rapids, WI 54495
 (715) 424-3310 • (800) 522-5661

Wausau
 802 Tulip Lane, Wausau, WI 54401
 (715) 359-8112 • (800) 221-5760

Kaukauna
 1900 Tower Dr., Kaukauna, WI 54130
 (920) 759-9280 • (800) 233-9122

CLOSEOUTS

WAUKESHA (continued)

PART NUMBER	DESCRIPTION	OH	SALE PRICE
HALDEX			
I1315	FRAME NIP	5	\$4.73 ea.
I6028	HOSE-AIR-	1	\$3.76 ea.
I6620	HOSE-AIR-	3	\$3.68 ea.
I6626	HOSE-AIR-	2	\$4.07 ea.
I6632	HOSE-AIR-	5	\$4.42 ea.
I6642	HOSE-AIR-	1	\$5.17 ea.
I6648	HOSE-AIR-	2	\$6.31 ea.
CB30	CLAMPBAND	2	\$4.14 ea.
KN20903	KNOB	1	\$6.33 ea.
AQ961110	ABS KIT	2	\$223.52 ea.
400-10212	AUTO SLACK 1.5" 28 spline 6" center to center	2	\$55.51 ea.
400-10215	AUTO SLACK 1.5" 10 spline 5.5" center to center	1	\$55.51 ea.
SC16-SP	CHAMBER	1	\$11.11 ea.
SC20-SP	CHAMBER	3	\$11.11 ea.
HOLLAND			
RK-02536	LATCH KIT for PH300 pintle hook	1	\$50.00 ea.
XB-SPN-053-36	SHOCK ABSORBER for Binkley AirLite 2 suspension	1	\$25.00 ea.
FREON			
R-12	FREON	87	\$19.80 ea.
R-500	FREON	30	\$14.67 ea.
R-502	FREON	59	\$17.11 ea.
BENDIX			
D184	BRK PADS	1	\$45.02 ea.
I07539	SR4 VALVE	1	\$168.09 ea.
H2588	HYDRAULIC BRAKE SELF ADJUSTER REPAIR KIT	1	\$10.34 ea.
H2589	HYDRAULIC BRAKE SELF ADJUSTER REPAIR KIT	1	\$10.34 ea.
H7055	HYDRAULIC DRUM BRAKE HARDWARE KIT	2	\$5.50 ea.
MK225HD	DISC PAD KIT	3	\$62.08 ea.
GTA-284412	VALVE	2	\$20.00 ea.
HUTCHENS			
H9700-QU-KIT	BOXED SUSPENSION KIT, QUAD AXLE UNDER MT HANGERS	1	\$750.00 ea.
H-20725-01	FRT HGR	2	\$25.00 ea.
H-00898-00	LOW-HUB	4	\$71.66 ea.
H-10060-01	U-BOLT	3	\$6.09 ea.
H-19360-01	SPRING SE	8	\$22.17 ea.
H-20248-01	BUSHING	6	\$47.83 ea.
H-00841-00	LOCK NUT	6	\$0.77 ea.
H-07052-02	SPR.PAD	4	\$1.22 ea.
H-08098-01	SPRING	2	\$0.60 ea.
H-17350-02	STL PAD	1	\$1.39 ea.
H9700-TUS	BOXED SUSPENSION KIT, TANDEM AXLE UNDERSLUNG	2	\$613.87 ea.
H-00835-02SP	UBOLT	8	\$8.89 ea.
FLEET ENGINEERS			
022-00966	TRAILMOBILE HINGE	2	\$5.00 ea.
022-01035	KENTUCKY HINGE	1	\$10.00 ea.
031-00129	MUDFLAP HANGER SET	2	\$30.17 ea.
022-00614	KENTUCKY HINGE	9	\$8.19 ea.
982-00255	CORNER PROTECTOR	13	\$0.91 ea.
022-00577	DOOR HOLDBACK	4	\$2.88 ea.
023-00557	FRUEHAUF HINGE	9	\$5.63 ea.
997-98016	TRAILMOBILE HINGE PIN	10	\$1.77 ea.
POWER BRACE			
04-85004-100-00	LH LK.ROD	2	\$47.34 ea.
04-85004-100-KIT	L/R ASSY	1	\$66.79 ea.
COMPETITIVE BODY PARTS			
NC6340	DOOR GSKT	24	\$1.17 ea.
WAB-E8411260	SIDE POST	1	\$69.68 ea.
TRUCKLITE			
T-30705	S/S RING	10	\$2.00 ea.
T-52200	120" AB	1	\$6.28 ea.



Visit us at our website:
<http://www.badger-utility.com>

Madison
 4334 Daentl Road, DeForest, WI 53532 (608) 249-5301 • (800) 362-7370

Wisconsin Rapids
 3112 Hwy. 13 North, Wis. Rapids, WI 54495 (715) 424-3310 • (800) 522-5661

Waukesha
 N10W24910 Hwy.TJ, Pewaukee, WI 53072 (262) 549-3655 • (800) 472-1022

Wausau
 802 Tulip Lane, Wausau, WI 54401 (715) 359-8112 • (800) 221-5760

Kaukauna
 1900 Tower Dr., Kaukauna, WI 54130 (920) 759-9280 • (800) 233-9122

CLOSEOUTS

WAUKESHA (continued)

PART NUMBER	DESCRIPTION	OH	SALE PRICE
TRUCKLITE (continued)			
T-97898	TURN SWTCH	1	\$39.52 ea.
T-35201Y	LED Model	20	\$5.38 ea.
T-60126R	LED Model	1	\$43.62 ea.
T50321-144SP	HARNESS	2	\$3.33 ea.
T77310-120SP	HARNESS	2	\$3.33 ea.
T77701-72SP	HARNESS	4	\$5.56 ea.
T77701-108SP	HARNESS	2	\$5.56 ea.
WHEELS			
29362ANP	8.25x24.5 uni-mt machine finish aluminum wheel	2	\$212.22 ea.
28409W-TO	8.25x24.5 uni-mt steel wheel	4	\$22.22 ea.
SB4220C	4X22 CORRUGATED WHEEL SPACER	3	\$9.91 ea.
42040-SP	4X20 WHEEL SPACER	1	\$5.56 ea.
BEARINGS			
HB563	BEARING	5	\$7.11 ea.
TBH715311	RACE	1	\$10.00 ea.
S552A	BEARING	3	\$15.36 ea.
S555S	BEARING	3	\$25.07 ea.
SET45280-20	BRG SET	1	\$28.18 ea.
SET47679-20	BRG SET	2	\$38.93 ea.
SHM212011	RACE	6	\$8.66 ea.
SHM516410	RACE	4	\$18.06 ea.
HM212049-SP	BEARING	31	\$10.00 ea.
HM218248-SP	BEARING	19	\$11.11 ea.
BRAKE PARTS			
M16WKL25-300	CAM	2	\$30.82 ea.
M16WKR25-300	CAM	2	\$30.82 ea.
SKF			
27370	SEAL	20	\$9.13 ea.
SRT-1	SEAL REMOVAL TOOL	2	\$45.64 ea.
1787	HUBCAP	2	\$20.83 ea.
1790	HUBCAP	4	\$19.87 ea.
453795	GASKET	16	\$0.93 ea.
44919	SCOTSEAL	1	\$10.00 ea.
45103	SCOTSEAL	2	\$10.00 ea.
CONMET			
107550	PRESET BEARING HUB SERVICE KIT TP AXLE	1	\$75.00 ea.
OVERHEAD DOORS			
100096098	TODCO DOOR ASSY	1	\$300.00 ea.
89291-0044	S/SRIVETS	34	\$0.48 ea.
69807	LOCK	2	\$152.82 ea.
84-3/4X99-1/8	TODCO DOOR ASSY	1	\$558.67 ea.
91HX94WALCLAD	TODCO DOOR ASSY	1	\$572.11 ea.
93-3/4X98-14	TODCO DOOR ASSY	1	\$651.74 ea.
FILTERS			
AF1046	FILTER	6	\$2.00 ea.
FP588F	FILTER	8	\$2.00 ea.
LFF3530	FILTER	1	\$2.00 ea.
LFW5875	FILTER	1	\$3.00 ea.
LP2016	FILTER	3	\$3.00 ea.
AF697	FILTER	8	\$8.31 ea.
AF917	FILTER	9	\$7.14 ea.
AF1618	FILTER	3	\$7.00 ea.
CAF1704	FILTER	4	\$7.20 ea.
G475	FILTER	9	\$2.36 ea.
LAF1839	FILTER	5	\$43.62 ea.
LAF1858	FILTER	1	\$23.80 ea.
LFF1131	FILTER	12	\$9.04 ea.
LFP3693F	FILTER	10	\$3.29 ea.
LFW4073	FILTER	2	\$9.01 ea.
L7264F	FILTER	2	\$10.32 ea.
LFF8000	FILTER	1	\$6.26 ea.



Visit us at our website:
<http://www.badger-utility.com>

Madison
 4334 Daentl Road, DeForest, WI 53532 (608) 249-5301 • (800) 362-7370

Wisconsin Rapids
 3112 Hwy. 13 North, Wis. Rapids, WI 54495 (715) 424-3310 • (800) 522-5661

Waukesha
 N10W24910 Hwy. TJ, Pewaukee, WI 53072 (262) 549-3655 • (800) 472-1022

Wausau
 802 Tulip Lane, Wausau, WI 54401 (715) 359-8112 • (800) 221-5760

Kaukauna
 1900 Tower Dr., Kaukauna, WI 54130 (920) 759-9280 • (800) 233-9122

CLOSEOUTS

WAUKESHA (continued)

PART NUMBER	DESCRIPTION	OH	SALE PRICE
FILTERS (continued)			
LFP670	FILTER	5	\$8.00 ea
LFW6500	FILTER	1	\$30.16 ea
FIRESTONE			
358-9241	AIRSPRING	2	\$103.13 ea
GROTE			
43253	FLANGE TH	4	\$3.49 ea
43572	BRACKET	48	\$1.79 ea
44720	FLASHER	1	\$16.87 ea
45463	LITE-AMB	2	\$4.23 ea
47982	CLR/MKR	7	\$10.93 ea
47983	CLR/MKR	10	\$10.93 ea
90122	LENS	1	\$0.59 ea
93803	BRACKET	3	\$2.14 ea
94220	GASKET, F	10	\$0.62 ea
99510	TERMKIT	7	\$5.72 ea
47953	CLR/MKR	6	\$9.07 ea
49202	CLR/MKR	1	\$27.90 ea
49203	CLR/MKR	1	\$27.90 ea
46412	CLR/MKR L	50	\$1.12 ea
HOLLAND			
RK-63505	FW3500/2535 5TH WHEEL REBUILD KIT (RH)	1	\$325.30 ea
RK-63500	FW3500/2535 5TH WHEEL REBUILD KIT (LH)	1	\$291.84 ea
PENZ			
P-1077	VENT DOOR	1	\$99.46 ea
PHILLIPS			
I-1893	16-14 ga SOLDER N SEAL FEMALE CONNECTOR	18	\$0.73 ea
I-1894	16-14 ga SOLDER N SEAL MALE CONNECTOR	25	\$0.73 ea
STEMCO			
342-4249	HUBCAP	2	\$29.94 ea
343-4065	HUBCAP	1	\$23.53 ea
347-4009	HUBO CAP	1	\$18.23 ea
429-0002	PINION SEAL MACK FRONT	9	\$36.58 ea
429-0004	PINION SEAL EATON 400 FRONT	8	\$35.21 ea
429-0006	PINION SEAL EATON 402 FRONT	8	\$34.70 ea
429-0008	PINION SEAL MACK FRONT	8	\$35.08 ea
429-0009	PINION SEAL MACK REAR	8	\$34.88 ea
XBC-STARTER	WHEEL BALANCE TAPE KIT	1	\$178.86 ea
HENDRICKSON			
B-2841-1	BUSHING	2	\$21.19 ea
B-20037	PLATE	8	\$11.37 ea
S-5332	PIVOT KIT	2	\$15.89 ea
S-22907/2	AIR SPRING	2	\$4.00 ea
S-24459-SP	HOLD DOWN	8	\$2.00 ea
SLKP7	SURELOK	1	\$134.14 ea
VS227TO	LEVELING VALVE	1	\$2.47 ea
AK155-SP	AIR CONTROL KIT	1	\$222.22 ea
UTAXLE10	77.5" TRACK 8-5/8 BRAKE 1/2" WALL AXLE	6	\$175.00 ea
UTAXLE11	77.5" TRACK 8-5/8 BRAKE 5/8" WALL AXLE	5	\$175.00 ea
HYDRAULICS			
34A043221-SP	VALVE HYD	2	\$55.56 ea
LIGHT/MEDIUM DUTY TRAILERS			
80281 CXL-SP	COUPLER	1	\$38.89 ea.
I82800-SP	CONVERT A BALL	1	\$22.22 ea.
AJ251615-SP	COUPLER	1	\$27.78 ea.
BDL253-SP	EYE LOCK	7	\$8.89 ea.
BM4HD-SP	BALL MOUNT	1	\$11.11 ea.
LT23585R16-SP	TIRE	1	\$55.56 ea.
D-5	"4" "RECIEVER"	1	\$12.09 ea.
10-10	SEAL	4	\$1.82 ea.
60R865E-ST-EZ	"6,000# AXLE 8 stud on 6.5" centers, electric brakes, EZ lube"	1	\$284.13 ea.



Visit us at our website:
<http://www.badger-utility.com>

Madison
 4334 Daentl Road, DeForest, WI 53532
 (608) 249-5301 • (800) 362-7370

Waukesha
 N10W24910 Hwy.TJ, Pewaukee, WI 53072
 (262) 549-3655 • (800) 472-1022

Wisconsin Rapids
 3112 Hwy. 13 North, Wis. Rapids, WI 54495
 (715) 424-3310 • (800) 522-5661

Wausau
 802 Tulip Lane, Wausau, WI 54401
 (715) 359-8112 • (800) 221-5760

Kaukauna
 1900 Tower Dr., Kaukauna, WI 54130
 (920) 759-9280 • (800) 233-9122

CLOSEOUTS

WAUKESHA (continued)

PART NUMBER	DESCRIPTION	OH	SALE PRICE
LIGHT/MEDIUM DUTY TRAILERS (continued)			
175010	JACK	2	\$26.49 ea.
SC1427	CHAIN	4	\$3.03 ea.
CARRAND			
CAR-93505	STACK BRUSH	3	\$22.63 ea.
TARPS			
2300/02	16' ROLL TARP	1	\$45.54 ea.
EMERGENCY LIGHTING			
304-6410A	STROBE AMBER	1	\$34.67 ea.
304-R5700LA	AMBER LENS	1	\$12.50 ea.
211740-05	CLEAR STROBE	1	\$120.28 ea.
602111-05	FLASHTUBE	1	\$23.56 ea.
ELECTRICAL			
0105	BULB	2	\$1.07 ea.
211-2	BULB	2	\$0.60 ea.
C93	LITE	20	\$0.18 ea.
C94	BULB	50	\$0.18 ea.
C194NA	MINIBULB	10	\$0.36 ea.
C2057	BULB	86	\$0.16 ea.
C3175	LIGHT	8	\$0.22 ea.
C9006	CAPSULE	1	\$1.21 ea.
CHIB9007	HEADLITE	2	\$5.09 ea.
CTS60	TUFFSKIN	42	\$0.83 ea.
ATC-30PK	30 AMP	17	\$1.41 ea.
ATO-5	FUSE	117	\$0.32 ea.
ATO-20	FUSE	5	\$0.44 ea.
ELSTON HEATER			
CAT900-USED	ELSTON CAT900 PORTABLE CATALYTIC CARGO HEATER	1	\$777.78 ea.
TOOL BOXES			
JBX62	BOX	1	\$94.91 ea.
KEMLITE			
KL120X12X48	KEMLITE	2	\$61.30 ea.
KIMBERLY CLARK			
KC-41455	WORKHORSE	10	\$6.82 ea.
LOAD RESTRAINT			
2231	TARPSTRAP	1	\$35.93 ea.
10039	BINDER	4	\$17.64 ea.
10049	ADJUSTABLE CHAIN BINDER	2	\$19.17 ea.
3705-2	CHAIN ANCHOR	8	\$6.36 ea.
77U9921	END STRAP	1	\$9.17 ea.
NATIONAL SEATS			
50061-335B	"SEAT,BLACK"	1	\$395.54 ea.
TOOLS			
SP-1	WHEEL CENTERING TOOL SET	2	\$218.34 ea.
10111T	SEAL TOOL	1	\$11.06 ea.
LOCTITE			
406-40462	SILICONE	2	\$8.06 ea.
406-40464	SILICONE	1	\$6.92 ea.
406-40480	GASKT MKR	4	\$10.03 ea.
406-40482	GASKT MKR	5	\$7.10 ea.
LINCOLN GREASE SYSTEMS			
408-51304	NYLOCK	89	\$0.30 ea.
408-244058	FITTING	3	\$4.10 ea.
408-274047	1/4" TUBE	5	\$25.87 ea.
408-241329	29PTKIT	3	\$624.32 ea.
408-3210-3A-CL	LUBEKIT	20	\$1,013.58 ea.
408-3210-4A1PID-CL	LUBEKIT	9	\$1,699.75 ea.
408-3210-4A2D2S-CL	LUBEKIT	9	\$1,737.78 ea.
408-3210-6A-CL	LUBEKIT	11	\$2,197.46 ea.
LIFTGATE PARTS			
226363-01	SPRING	1	\$29.12 ea.
85803819	COIL SPNG	1	\$21.92 ea.



Visit us at our website:
<http://www.badger-utility.com>

Madison
 4334 Daentl Road, DeForest, WI 53532
 (608) 249-5301 • (800) 362-7370

Waukesha
 N10W24910 Hwy.TJ, Pewaukee, WI 53072
 (262) 549-3655 • (800) 472-1022

Wisconsin Rapids
 3112 Hwy. 13 North, Wis. Rapids, WI 54495
 (715) 424-3310 • (800) 522-5661

Wausau
 802 Tulip Lane, Wausau, WI 54401
 (715) 359-8112 • (800) 221-5760

Kaukauna
 1900 Tower Dr., Kaukauna, WI 54130
 (920) 759-9280 • (800) 233-9122

CLOSEOUTS

WAUKESHA (continued)

PART NUMBER	DESCRIPTION	OH	SALE PRICE
LIFTGATE PARTS (continued)			
AMT0077	MOTOR	2	\$71.67 ea.
AMT0301	MOTOR	2	\$72.22 ea.
APL2250	SWITCH	9	\$7.06 ea.
APL3390	SOLENOID	1	\$52.22 ea.
UJOINTS			
K5-170X	U-JOINT	4	\$4.39 ea.
K5-677X	U-JOINT	1	\$32.17 ea.
FONTAINE 5TH WHEEL PARTS			
SPR338	SPRING	4	\$6.41 ea.
SPR374	SPRING	8	\$10.11 ea.
FLOORING			
FLB0072BA	7-1/4" APITONG NAILING BOARD, PER FOOT	306	\$2.97 ea.
AE53400-4824	6" ALUMINUM DRYFREIGHT FLOOR BOARD	6	\$236.11 ea.
ETERSON LIGHTING			
416-K	LAMP KIT	4	\$6.39 ea.
417SA-1	LED STRBE	1	\$68.83 ea.
423QA-P	LED LITE	2	\$50.43 ea.
485-A	REFLEC	28	\$0.42 ea.
485-R	REFLEC	8	\$0.51 ea.
490-R	REFLECTOR	18	\$0.66 ea.
M419	REAR LITE	2	\$22.50 ea.
V7009S	SEC.RING	23	\$2.52 ea.
PREMIER			
PR152	LATCH	1	\$43.10 ea.
PR207L	EYE	1	\$122.06 ea.
SOLAGIZER			
735X322	SOLAGIZER	1	\$40.63 ea.
PRO HEAT PAN HEATERS			
512-156	PROHEAT	3	\$26.11 ea.
AEROQUIP FITTINGS			
70R1596	FITTING	8	\$11.01 ea.
70R2061	#10SPLICE	1	\$5.77 ea.
70R2068	FITSPLICE	2	\$5.43 ea.
70R3001	ADAPTER	2	\$1.02 ea.
70R4201	#10 STR	3	\$1.98 ea.
70R4206	#6 STR	6	\$1.67 ea.
70R4208	#8 STR	2	\$1.77 ea.
70R4291	#10 90DEG	13	\$2.27 ea.
70R4296	#6-90DEG	8	\$1.76 ea.
70R4298	#8 90DEG	5	\$2.10 ea.
70R4408	#8 STR	1	\$2.61 ea.
70R4448	FITTING	2	\$3.38 ea.
70R4491S	#10 90DEG	2	\$4.79 ea.
70R4492S	#12 90DEG	6	\$7.28 ea.
70R4991	FITTING	3	\$6.57 ea.
70R5100	SHRADER	1	\$4.71 ea.
403276	#6 HOSE	24	\$1.43 ea.
403277	#8 HOSE	48	\$1.67 ea.
403278	#10 HOSE	38	\$1.89 ea.
403279	#12 HOSE	35	\$2.17 ea.
409000	FITTING	2	\$6.67 ea.
409002	#10 90DEG	7	\$5.51 ea.
409022	#6 90DEG	7	\$4.17 ea.
409023	#8 STR	9	\$4.54 ea.
409024	#10 STR	6	\$4.89 ea.
409025	#12 STR	10	\$6.29 ea.
409054	SPLIC#6#6	6	\$3.30 ea.
AMEREX FIRE EXTINGUISHERS			
A620T	FIRE EXT	4	\$23.89 ea.
ROLL-RITE TARP SYSTEMS			
564-4601	bracket	1	\$77.78 ea.



Visit us at our website:
<http://www.badger-utility.com>

Madison
 4334 Daentl Road, DeForest, WI 53532
 (608) 249-5301 • (800) 362-7370

Waukesha
 N10W24910 Hwy.TJ, Pewaukee, WI 53072
 (262) 549-3655 • (800) 472-1022

Wisconsin Rapids
 3112 Hwy. 13 North, Wis. Rapids, WI 54495
 (715) 424-3310 • (800) 522-5661

Wausau
 802 Tulip Lane, Wausau, WI 54401
 (715) 359-8112 • (800) 221-5760

Kaukauna
 1900 Tower Dr., Kaukauna, WI 54130
 (920) 759-9280 • (800) 233-9122

CLOSEOUTS

WAUKESHA (continued)

PART NUMBER	DESCRIPTION	OH	SALE PRICE
ROLL-RITE TARP SYSTEMS (continued)			
564-4602	bracket	1	\$77.78 ea.
SEALCO			
6006	NIPPLE	21	\$4.37 ea.
SECURITY CHAIN TIRE AND LOAD RESTRAINT			
TC4517-00	CABLCHAIN	11	\$86.67 ea.
ZT835	CABLES	1	\$119.44 ea.
ZT982	Z-CHAINS	1	\$208.04 ea.
ZT990	SUPER""Z""	1	\$214.98 ea.
QG4247CAM	DUALS	5	\$85.68 ea.
CC5010	SMARTBAR	5	\$16.94 ea.
H5857-0652	3/8"" HAL	6	\$6.78 ea.
H5857-0852	LINK 1/2"	6	\$9.94 ea.
H8326-0415	CONNECTI	18	\$1.60 ea.
H8526-0420	TRANSPORT	2	\$2.29 ea.
H8625-0613	3/8" S-8	1	\$4.47 ea.
H8625-0813	1/2" S-8	4	\$6.59 ea.
H8645-0415	1/4" FOR	5	\$0.91 ea.
TRICO WIPER BLADES			
14-2	WIPER	8	\$3.73 ea.
37-240	WIPER	3	\$7.03 ea.
TRIUMPH TWIST DRILL BITS			
011404	DRILLBIT	8	\$0.52 ea.
011405	DRILLBIT	15	\$0.52 ea.
011419	19/64 BIT	65	\$1.82 ea.
011421	21/64 BIT	9	\$2.07 ea.
011423	23/64	30	\$2.62 ea.
011427	27/64 BIT	6	\$3.43 ea.
011428	7/16 BIT	7	\$3.67 ea.
011429	29/64 BIT	4	\$4.28 ea.
011430	15/64 BIT	5	\$4.32 ea.
011431	31/64 BIT	5	\$4.51 ea.
WEBB WHEEL PRODUCTS			
54301P	DISC BRAK	4	\$85.29 ea.
63410F	DRUM	4	\$361.82 ea.
65543B	DRUM	3	\$164.50 ea.
66816F	BRAKE DRU	4	\$267.81 ea.
66875B	BRAKE DRU	4	\$128.49 ea.
MISC			
1/4-COPPER	1/4-coppr	67	\$1.14 ea.
004-4000-1	RED LED	5	\$4.88 ea.
41TS3	VALVE	4	\$35.42 ea.
289-350	QUICKTHAW	45	\$2.74 ea.
02508	10GA/RED	90	\$0.14 ea.
02510	10GA/BLK	78	\$0.14 ea.
A701	LOCK	2	\$27.58 ea.
AGF-316	3/16HOSE	20	\$1.43 ea.
CRANK-BOLT	BOLT KIT	14	\$1.00 ea.
CRANKHANDLE	CRANK ARM	10	\$3.00 ea.
CUI05VINYL	CHUTE 48'	1	\$94.44 ea.
FL	FLASHLITE	1	\$17.07 ea.
HB0204	3 STEP	2	\$275.46 ea.
HH66T	THINNER	2	\$5.00 ea.
LF3349	FILTER	3	\$6.49 ea.
Q303018PCIQR	BOX	1	\$79.92 ea.
QE2	quick-e	4	\$15.78 ea.
WMI147F	PILOTVLY	1	\$64.90 ea.
BRIGADE ELECTRONICS			
BI381	REAR VIEW CAMERA SYSTEM - COLOR	3	\$424.00 ea.
BI385	REAR VIEW CAMERA SYSTEM - MONOCHROME	3	\$156.00 ea.

FALL SPECIALS

Expires November 30, 2008

INTERNATIONAL SPECIALS (WHILE SUPPLY LASTS)

	PART #	DESCRIPTION	QTY	SELL
BWP	M-3202	UNI-STUD	100	\$2.65
	M-3217	UNI STUD	100	\$2.76
	M-K16	CAM KIT	50	\$6.05
3 LEAF HEAVY DUTY HI ARCH HUTCHENS TRAILER SPRING	TRA2740	365-00 HUTCHENS	50	\$59.86
23,000# SEVERE DUTY NEW LINED BRAKE SHOES	GG4515QN	NEW LINED BRAKE SHOE	20	\$24.92
BINKLEY SUSPENSION PARTS	SP0194-15	3" SPRING SEAT SPACER	20	\$20.05
	SL8184-48	SLIDERBOX	1	\$759.55
	SL810448-USED	USED SLIDER ASSY	3	\$300.00
8.25 X 22.5 UNI MOUNT STEEL WHEEL	28408W	STEEL WHEELS 8/PALLET (MIN 8 ORDER)	25	\$639.60 <small>(pallet of 8 = \$79.95 ea.)</small>
FIRESTONE AIR SPRING	358-9640	AIR SPRING HENDRICKSON S20223 (HT/HS 190T)	30	\$105.92
NEWAY LEVELING VALVE	90054007	LEVELING VALVE	10	\$41.11
STEMCO WHEEL SEAL - TRAILER AXLE	307-0743	SEAL	100	\$26.70
DANA AXLE 77.5" TRACK (102") 7" BRAKE 1/2" WALL	04-0450-0-169	102" AXLE 77.5" TRACK X 7" BRAKE X 1/2" WALL	2	\$599.72
TOOLS	220-8944	1-3/8" IMPACT DEEP SOCKET 1" DRIVE	1	\$53.76
	220-8946	1-7/16" IMPACT DEEP SOCKET 1" DRIVE	1	\$63.34
	SM104555	RIVET SET (5/32 BRAZIER HD)	2	\$23.94
	SM104556	RIVET SET (3/16 BRAZIER HD)	2	\$23.94
	SM104558	RIVET SET (1/4 BRAZIER HD)	2	\$23.94
	SM104706	RIVET SET (3/16 UNIVERSAL HD)	2	\$23.94
	SM104708	RIVET SET (1/4 UNIVERSAL HD)	2	\$23.94

AD	PAGE
BAWER	8, 9
FPPF	1, 2
DEPENDABLE/UNI-BOND	10
FEDERAL SIGNAL	15
GROTE	7
HALDEX	3
INTERNATIONAL	24
KINEDYNE	5
LITEGARD	16
MERRITT	6
MINIMIZER	9

AD	PAGE
NATIONAL SEAT	12
NORCO	10
PENRAY	4
PHILLIPS	3
PRECO	15
PREMIER	5
RETRAC	14
SECURITY CHAIN	11
SOUTHWEST	6
STEMCO	13
TRUCK-LITE	8



Wisconsin Rapids
(715) 424-3310
(800) 522-5661

Madison
(608) 249-5301
(800) 362-7370

Waukesha
(262) 549-3655
(800) 472-1022

Wausau
(715) 359-8112
(800) 221-5760

Kaukauna
(920) 759-9280
(800) 233-9122